

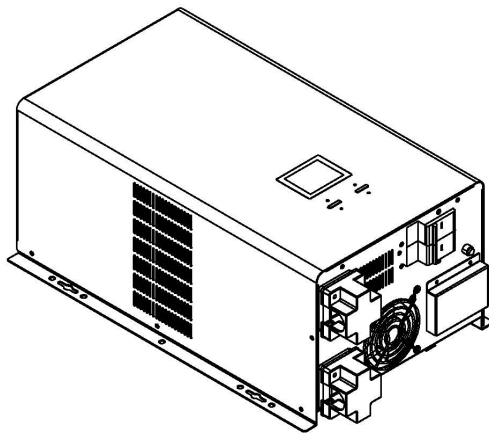

Operation Manual

Pure Sine Wave Inverter Model

UPS-HEATST-COMMANDER300W-WL
UPS-HEATST-COMMANDER600W-WL

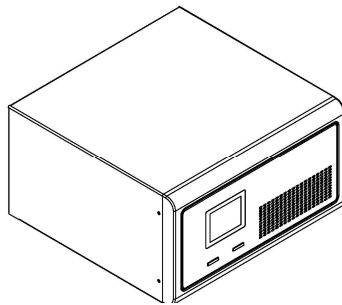

This product benefits 2+1 years warranty.
For more information please access site www.well.ro

Thank you for choosing WELL. Please read carefully the following instructions and keep them within reach.

1. Safety Information

 CAUTION
Non-qualified electricians are forbidden to open the case due to hazard of electrical shock.
This equipment is not design to be used for below or similar applications: <ul style="list-style-type: none">• Medical equipment which is directly related to patients'life• Elevator and other equipment which may endanger personal safety• Traffic, nuclear, aviation systems• Apply to all kind of safety devices or special usages

General safety and cautions

- Read all safety information and operating instructions carefully before using this inverter.
- Do not disassemble this inverter. Contact your local service center if maintenance or repair is needed.
- Disconnect all connection wiring before maintenance or cleaning to avoid the risk of electric shock.
- Do not use liquid extinguisher if there is a fire, a dry powder extinguisher is recommended.
- Do not dispose of the batteries with fire. The batteries may explode.
- Do not open or mutilate batteries. Released electrolyte inside is harmful to the skin and eyes, and maybe toxic.
- Do not connect the positive pole and negative pole directly, otherwise it will cause electric shocks or will be on fire.

2 Product Overview

2.1 Specifications

MODEL	300W	600W	1000W	1600W	2500W	3500W
DC Input (the inverter must be connected to batteries to work properly)						
Nominal input voltage	12V			24V		
DC input range	10 ~ 15V			20 ~ 30V		
AC Input						
Bypass input range	0 ~ 264Vac for 220Vac/230Vac/240Vac					
Mains input range	150 ~ 282Vac for 220Vac, 156 ~ 294Vac for 230Vac, 163 ~ 307Vac for 240Vac					
Input frequency range	50Hz / 60Hz (Auto-sense), 45 ~ 55Hz for 50Hz, 55 ~ 65Hz for 60Hz					
Input range of the generator	99 ~ 282Vac for 220Vac, 104 ~ 294Vac for 230Vac, 108 ~ 307Vac for 240Vac No AVR in generator mode					
Input frequency range of the generator	40 ~ 70Hz					
Input power matching of the generator	Rated power 10% ~ 120%, regulating step 10%, default 120%					
Output						
Inverter output range	220V / 230V / 240Vac \pm 5%					
Bypass output range	0 ~ 264Vac for 220V/230V/240V,					
Mains output range	174 ~ 242Vac for 220Vac, 182 ~ 253Vac for 230Vac, 190 ~ 264Vac for 240Vac					
Output frequency	50Hz / 60Hz \pm 0.3 (Auto-sense & settable)					
Output waveform	Pure sine wave					
Output power	300W	600W	1000W	1600W	2500W	3500W
Efficiency	Max. 95% (Mains mode); Max. 80% (Inverter mode)					
ECO mode	Enter in 80 s after load is less than 3%					
No-load shutdown	Settable, shutdown in 80 s					
Load rate in No-load shutdown	Settable, 3% ~ 50% optional, default 3%					
Transfer time	\leq 10 ms				\leq 15 ms	
Power factor	1.0					
THDV	< 5% (linear load)					
Inductive load	Yes					
Motor load	Yes					

Rectifier load	Yes					
Overload capability	Mains mode: 110% 120 s, 125% 60 s, 150% 10 s (switch to bypass) Inverter mode: 110% 60s; 125% 10 s; 150% 0.7 s (shut down)					
Battery						
Charging current (selectable)	Default 10A	Default 20A, regulating step 1A (< 10A) / 5A (> 10A)				
	Max. 15A	Max. 30A	Max. 40A	Max. 40A	Max. 50A	Max. 60A
Equalizing charge voltage	Single battery 14.1Vdc (default), 13.6 ~ 15Vdc settable					
Floating charge voltage	Single battery 13.5Vdc (default), 13.2 ~ 14.6Vdc settable					
EOD	Single battery 10.2Vdc (default), 9.6 ~ 11.5Vdc settable					
Reverse warning	Buzzer					
Alarm						
Switch on / off	Continuous beep 2 s					
Low battery	Beep 0.2 s at interval of 0.4 s					
Overload	Beep 2 s at interval of 2.5 s					
Mains power abnormal	Beep 0.3 s at interval of 5 s					
Others						
Protections	Overload –short-circuit – overvoltage – undervoltage – overcharge – overtemperature – excessive low battery					
Interface	LCD & BUZZER					
Noise	≤50dB					
IP Rating	IP20					
Operating temperature	0°C ~ 40°C					
Operating humidity	Relative humidity ≤ 93%					
Altitude	< 1000m, (above 1000m, derating 1% for each additional 100 m), 4000 m max.					
Net weight (kg)	8.3	11.3	14.0	20.2	32.0	36.0
Gross weight (kg)	9.3	12.3	15.0	21.2	34.0	38.0
Dimensions (W×D×H) mm	293×280×160				302×479×209	
Packaged dimensions (W×D×H) mm	370×355×235				353×582×287	

Note: Specifications are subject to change without notice

Charging features

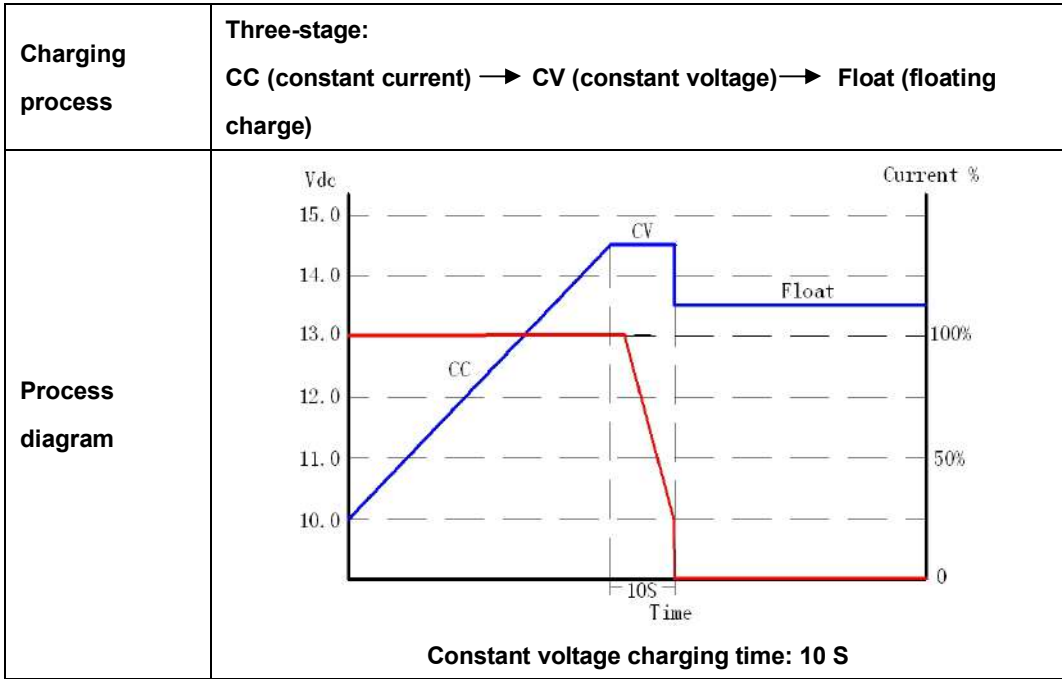

2.2 Front panel features

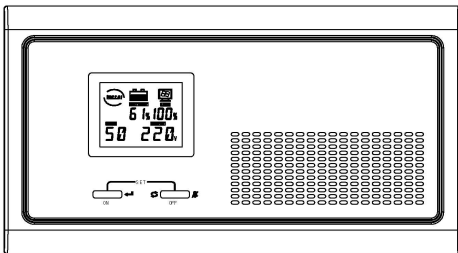

300W ~ 1600W front panel

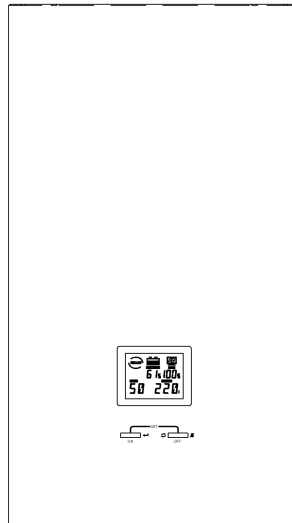

2500W ~ 3500W front panel

2.3 Rear panel features

300W ~ 1600W rear panel

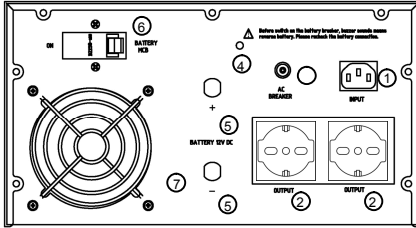

- ① AC input socket
- ② Output sockets
- ③ Overcurrent protector
- ④ Buzzer for battery reverse
- ⑤ Battery wiring
- ⑥ Battery breaker
- ⑦ Fan

2500W ~ 3500W rear panel

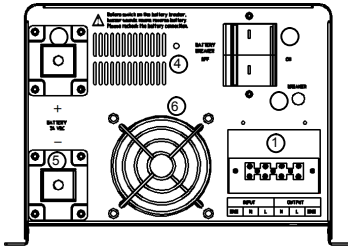



- ① Input / output terminal block
- ② Overcurrent protector
- ③ Battery breaker
- ④ Buzzer for battery reverse
- ⑤ Battery wiring terminal
- ⑥ Fan

3 Installation Instructions

3.1 Unpacking Inspection

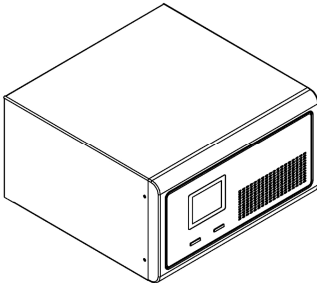
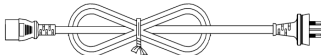
Inspect the contents upon receipt. Notify the carrier and dealer if the unit is damaged.

300W ~ 1600W package contents		
 <p>300W ~ 1600W Inverter</p>	 <p>AC input power cords</p>	 <p>Operation manual</p>

2500W ~ 3500W package contents

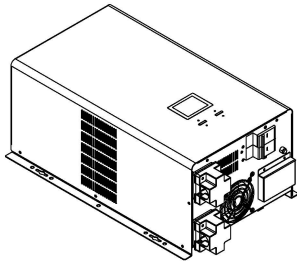

2500W ~ 3500W Inverter

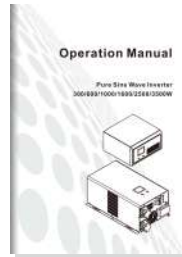

Operation manual

3.2 Installation

CAUTION

The inverter is designed for indoor use. Do not operate this UPS in direct sunlight, in contact with fluids, or where there is excessive dust or humidity.

Place batteries in sound ventilation environment.

Use insulated tools to reduce the risk of short-circuit when installing or working with the inverter, the batteries, or other equipments attached to this unit.

Be sure that the ground terminal has been connected with the ground.

3.2.1 Installation information

- Inspect whether the battery voltage and Mains voltage are correct or not.
- Connect the inverter with batteries, utility power and loads. Be sure all wiring is correct, terminals are screwed tightly and terminal cover is locked.
- Open the battery breaker, press ON button, then the inverter starts up in 3 seconds, and then check if the load has problem (overload, short-circuit ect.). If it does, check and correct until confirming it is normal, and then connect to the utility power.

3.2.2 Connect external battery

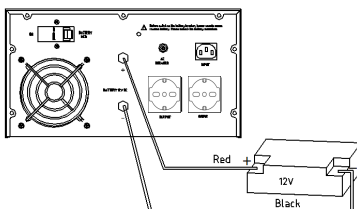

300W / 600W / 1000W DC12V inverter battery connection diagram

(Note that the red cable is connected to the positive terminal, black cable is connected to the negative terminal)

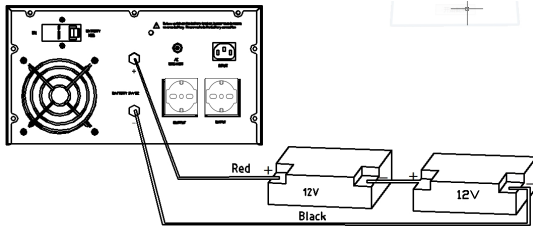

1600W DC24V inverter battery connection diagram

(Note that the red cable is connected to the positive terminal, black cable is connected to the negative terminal)

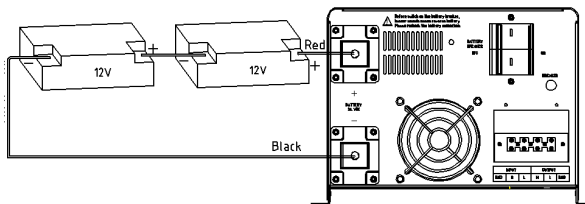

2500W / 3500W DC24V inverter battery connection diagram

(Note that the red cable is connected to the positive terminal, black cable is connected to the negative terminal, and 2500W battery cable is more than 35mm², 3500W battery cable is more than 50mm²)

4 Operations

CAUTION

Turn on the inverter in battery mode first. Be sure that the load has no problem (overload, short-circuit ect.) before connecting to utility power.

4.1 Turn the inverter On/Off

- Without connecting to utility power, press and hold “ON” button for 3 seconds, release it until the buzzer beeps, the inverter starts up. In the process of the inverter running, press and hold “OFF” button for 3 seconds, release it until the buzzer beeps, the inverter is shut down.
- When the inverter works in mains power / AC mode, press and hold “OFF” button for 3 seconds, release it until the buzzer beeps, the inverter goes to bypass mode.
- When the inverter works in bypass mode, press and hold “ON” button for 3 seconds, release it until the buzzer beeps, the inverter goes to AC mode.

4.2 Display interface

Inverter mode

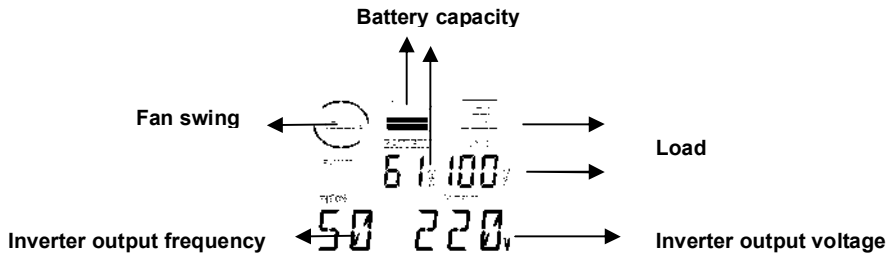

Mains power mode





4.3 Settings

4.3.1 Setting operation

- In normal mode, press and hold “ON” + “OFF” button at the same time for 3 seconds to go to Setup mode.
- In Setup mode, press and hold “ON” + “OFF” button at the same time for 3 seconds to exit from Setup mode, and the setting are not saved.
- In Setup mode, press “ON” button for page turning to select configuration options.
- In Setup mode, press “OFF” button to configure current settings.
- In Setup mode, press “ON” button to turn to page “Save & Exit” interface, press “OFF” button and select “Y”, then press “ON” button to confirm to save datas and exsit from Setup mode.
- After the setting is configured, shut down and restart the inverter before the settings takes effect.
- In normal mode and starting state, press “OFF” button to mute.
- If there is failure and failure is solved, press “OFF” button first and release it to press “ON” button, and restart the inverter for normal use.

4.3.2 General settings

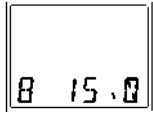
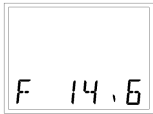
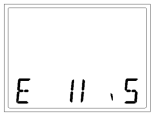
Configure these settings at any time, using the display interface.

No.	Parameters	Default Value	Options	LCD display
1	OUT: Rated output voltage of the inverter	220V	220V / 230V / 240V	OUT 240
2	HZ: Rated output frequency of the inverter	50HZ	50HZ / 60HZ	HZ 60
3	B: Equalizing charge voltage	14.1V	13.6V ~ 15.0V	
4	F: Floating charge voltage	13.5V	13.2V~14.6V	
5	E: End of discharge voltage	10.2V	9.6V ~ 11.5V	
6	CUR: Charging current	10A (300W) 20A (600W ~ 3500W)	0 ~ 60A	CUR 60
7	IECO: Inverter no-load ECO mode Note: If select "Y", check whether the configured load rate in "Inverter shutdown load rate" is correct or not, if not, change it.	N	Y / N	
8	INLS: Inverter no-load shutdown function Note: If select "Y", check whether the configured load rate in "Inverter shutdown load rate" is correct or not, if not, change it.	N	Y / N	INLS N



9	DCAU: DC auto restart function Note: If select "Y", check whether the configured time in "DC auto restart time" is correct or not, if not, change it.	N	Y / N	DCAU N
10	ACAU: AC self-starting function	Y	Y / N	ACAU N
11	INP: Input power matching of the generator	120%	10% ~ 120% (based on rated power)	INP 120
12	INLS: Inverter shutdown load rate	3%	3% ~ 50% (based on rated power)	INLS 50
13	T: DC auto restart time	1H	0.5H ~ 8.0H	T 8.0H
14	SAVE: Save and Exit		Y / N	SAVE N

4.4 Troubleshooting

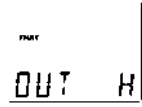
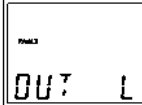
This section lists the status and alarm messages that the UPS might display. A suggested corrective action is listed with each display message to help you troubleshoot problems.

No.	Problem Description	Display Message	Corrective Action
1	AC output short circuit		Check if the load is short circuited.
2	AC output voltage is too high		Contact the dealer or supplier from whom it was purchased.
3	AC output voltage is too low		Contact the dealer or supplier from whom it was purchased.

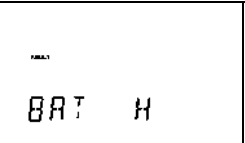
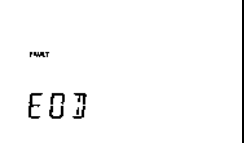
4	Output overload		Check the load.
5	Relay fault		Contact the dealer or supplier from whom it was purchased.
6	MOSFET over-current		Contact the dealer or supplier from whom it was purchased.
7	MOS overtemperature		Decrease the operating load. Contact the dealer or supplier if the problem persists.
8	Connection of heat sink and temperature sensor abnormal		Contact the dealer or supplier from whom it was purchased.
9	Transformer overtemperature		Decrease the operating load. Contact the dealer or supplier if the problem persists.
10	Inverter AC output voltage is too high		Contact the dealer or supplier from whom it was purchased.
11	Inverter AC output voltage is too low		Contact the dealer or supplier from whom it was purchased.
12	Soft-start fault		Contact the dealer or supplier from whom it was purchased.
13	BUS voltage is too high (Battery is overcharged)		Check the battery voltage. Contact the dealer or supplier if the problem persists.
14	Charging over-current		Contact the dealer or supplier from whom it was purchased.

15	Battery voltage is too high		Check the battery voltage.
16	Battery over-discharge protection		Check the battery voltage
17	Fault self-locking		Wait for auto clearance or manually shut down and restart the inverter

Ecological information:

Waste electrical and electronic equipment are a special waste category, collection , storage, transport , treatment and recycling are important because they can avoid environmental pollution and are harmful to health

Submitting waste electrical and electronic equipment to special collection centers makes the waste to be recycled properly and protecting the environment. Do not forget !Each electric appliance that arrive at the landfill, the field , pollute the environment!



Importer & distributor:

SC VITACOM ELECTRONICS SRL

CIF: RO 214527

Tel. 0264-438401*

sales@vitacom.ro

www.vitacom.ro



well®

Manual de Instrucțiuni

**Invertor Undă Sinusoidală Pură
Model**

**UPS-HEATST-COMMANDER300W-WL
UPS-HEATST-COMMANDER600W-WL**

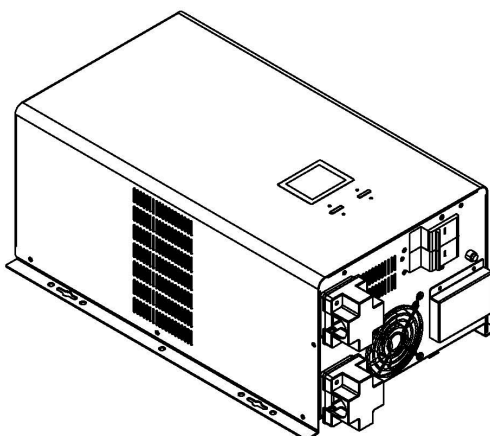
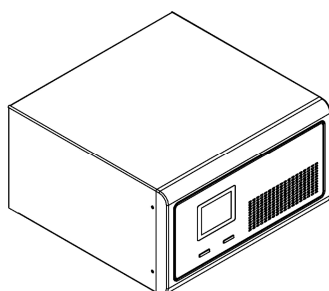

Acest produs beneficiază de garanție 2+1 ani.

Pentru mai multe informații vă rugăm accesați siteul www.well.ro

Vă mulțumim că ați ales acest produs WELL. Citiți cu atenție și păstrați aceste instrucțiuni la îndemână pe toată perioada utilizării aparatului.

1 Informații în privința siguranței

AVERTIZARE

Electricienilor necalificați li se interzice să deschidă carcasa din cauza pericolului de electrocutare.

Acest echipament nu poate fi folosit pentru aplicații cum ar fi:

- Echipamente medicale care pot influența viața sau sănătatea pacientului
- Elevatoare și alte echipamente care ar putea pune în pericol siguranța personală.
- Aplicații pe sistemul de trafic
- Aplicații pe sisteme nucleare, aviație, aeronave, aerospațiale
- Aplicații pentru toate aparatele de securizare și alte întrebuințări speciale



Siguranța generală și precauții

- Citiți toate informațiile în privința siguranței și toate instrucțiunile de funcționare cu atenție înainte de utilizarea acestui invertor.
- Nu dezamblați acest invertor. Contactați-vă centrul de reparații local în cazul în care este necesară mentenanță sau reparația.
- Deconectați toate cablurile de conectare înainte de mentenanță sau curățare pentru a evita riscul de electrocutare.
- Nu utilizați extingtorul lichid în cazul în care este un incendiu, un extingtor cu pudră uscată este recomandat.
- Nu aruncați bateriile în foc. Bateriile ar putea să explodeze.
- Nu deschideți sau nu loviți bateriile. Electroliții eliberați din interior sunt periculoși pentru piele și pentru ochi, și ar putea fi toxici.
- Nu conectați polul pozitiv cu polul negativ, acest lucru ar putea provoca electrocutări sau incendiu.

2 Prezentarea Produsului

2.1 Specificații

MODELUL	300W	600W	1000W	1600W	2500W	3500W
Intrare DC (invertorul trebuie să fie conectat la baterii pentru a funcționa corect)						
Tensiune nominală intrare	12V			24V		
Rază intrare DC	10 ~ 15V			20 ~ 30V		
Intrare AC						
Tensiune intrare bypass	0 ~ 264Vac pentru 220Vac/230Vac/240Vac					
Tensiune intrare rețea	150 ~ 282Vac pentru 220Vac, 156 ~ 294Vac pentru 230Vac, 163 ~ 307Vac pentru 240Vac					
Rază frecvență intrare	50Hz / 60Hz (Auto detecție), 45 ~ 55Hz pentru 50Hz, 55 ~ 65Hz pentru 60Hz					
Raza de intrare a generatorului	99 ~ 282Vac pentru 220Vac, 104 ~ 294Vac pentru 230Vac, 108 ~ 307Vac pentru 240Vac Fără reglare de tensiune în modul generator					
Raza frecvenței de intrare a generatorului	40 ~ 70Hz					
Congruența energiei de intrare a generatorului	Putere nominală 10% ~ 120%, pas reglementare 10%, implicit 120%					
Ieșire						
Tensiune ieșire inverter	220V / 230V / 240V AC ± 5%					
Tensiune ieșire bypass	0 ~ 264V AC pentru 220V/230V/240V					
Tensiune ieșire rețea	174 ~ 242Vac pentru 220Vac, 182 ~ 253Vac pentru 230Vac, 190 ~ 264Vac pentru 240Vac					
Frecvență ieșire	50Hz / 60Hz ± 0.3 (Auto detecție și setabilă)					
Formă undă ieșire	Undă pură sinusoidală					
Putere ieșire	300W	600W	1000W	1600W	2500W	3500W
Eficiență	Max. 95% (Modul rețea); Max. 80% (Modul inverter)					
Modul ECO	Intră în 80 sec. după ce încărcarea este mai puțin de 3%					
Oprire fără încărcare	Setabilă, oprire în termen de 80 sec.					
Rata încărcăturii în oprirea Fără încărcare	Setabilă, 3% ~ 50% opțional, implicit 3%					
Timpul de transfer	≤10 ms			≤ 15 ms		
Factorul de putere	1.0					
THDV	< 5% (încărcare liniară)					
Încărcare de inducție	Da					
Încărcare motor	Da					

Încărcare rectificator	Da							
Capacitate supraîncărcare	Modul rețea: 110% 120 s, 125% 60 s, 150% 10 s (comutare pe bypass) Modul inverter: 110% 60s; 125% 10 s; 150% 0.7 s (oprire)							
Bateria								
Curentul de încărcare (selectabil)	Implicit 10A	Implicit 20A, pasul de reglementare 1A (< 10A) / 5A (> 10A)						
	Max. 15A	Max. 30A	Max. 40A	Max. 40A	Max. 50A	Max. 60A		
Tensiune încărcare egalizator	Baterie singură 14.1Vdc (implicit), 13.6 ~ 15Vdc setabilă							
Tensiune încărcare plutitoare	Baterie singură 13.5Vdc (implicit), 13.2 ~ 14.6Vdc setabilă							
EOD (nivel descărcare baterie)	Baterie singură 10.2Vdc (implicit), 9.6 ~ 11.5Vdc setabilă							
Avertizare polaritate inversă	Buzzer							
Alarmă								
Pornire / oprire	Beep continuu la 2 secunde							
Baterie în curs de descărcare	Beep la 2 secunde la un interval de 0.4 secunde							
Supraîncărcare	Beep la 2 secunde la un interval de 2.5 secunde							
Energie rețea anormală	Beep la 0.3 secunde la un interval de 5 secunde							
Altele								
Protecții	Supraîncărcare – scurtcircuit – supratensiune – subtensiune – supraîncărcare- supraîncălzire – baterie extrem de descărcată							
Interfața	LCD și BUZZER							
Nivel zgomot	≤50dB							
Factor protecție la umiditate	IP20							
Temperatura de funcționare	0°C ~ 40°C							
Umiditatea de funcționare	Umiditatea relativă ≤ 93%							
Altitudinea	< 1000m, (peste 1000m, reducere de 1% pentru fiecare 100 m. suplimentari), 4000 m max.							
Greutatea netă (kg)	8.3	11.3	14.0	20.2	32.0	36.0		
Greutatea brută (kg)	9.3	12.3	15.0	21.2	34.0	38.0		
Dimensiuni (W×D×H) mm	293×280×160				302×479×209			
Dimensiuni ambalare (W×D×H) mm	370×355×235				353×582×287			

Observație: Specificațiile sunt supuse schimbării fără un preaviz

Caracteristici în privința încărcării

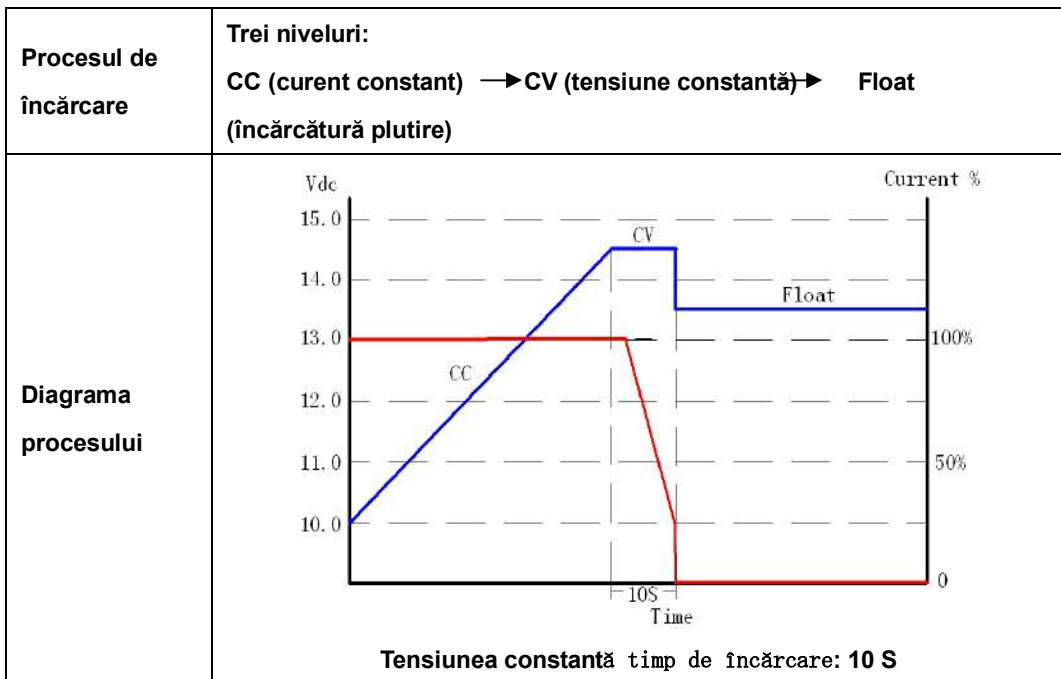

2.2 Caracteristici panou frontal

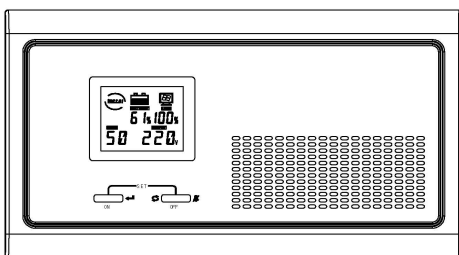

300W ~ 1600W panou frontal

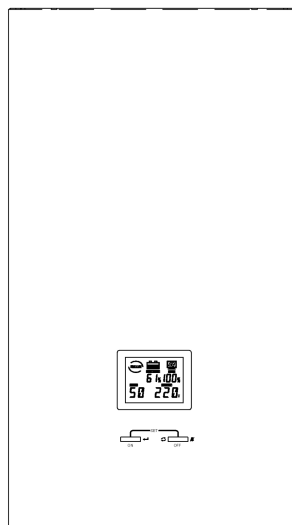

2500W ~ 3500W panou frontal

2.3 Caracteristici panoul din spate

300W ~ 1600W panoul din spate

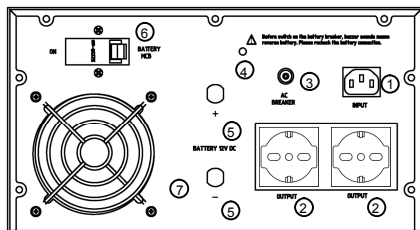

- ① Mufă intrare AC
- ② Mufe ieșire
- ③ Siguranță supra-curent
- ④ Buzzer polaritate inversă a bateriei
- ⑤ Cablaj baterie
- ⑥ Disjunctor baterie
- ⑦ Ventilator

2500W ~ 3500W panoul din spate

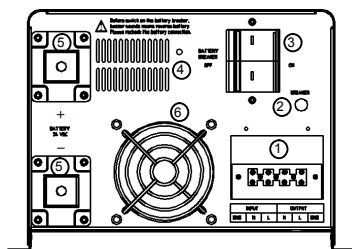



- ① Bloc terminal intrare / ieșire
- ② Protecție supra-curent
- ③ Disjunctor baterie
- ④ Buzzer polaritate inversă a bateriei
- ⑤ Terminal cablaj baterie
- ⑥ Ventilator

3 Instrucțiuni în privința Instalării

3.1 Inspecția la Despachetare

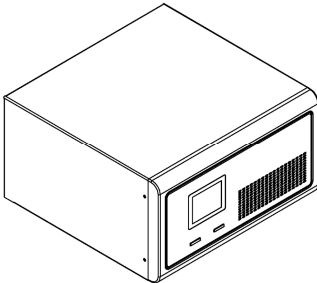
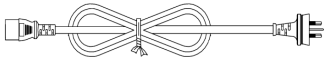
Inspectați conținutul la primire. Notificați transportatorul și furnizorul dacă unitatea este deteriorată.

300W ~ 1600W conținut pachet		
		
300W ~ 1600W Invertor	Cablul de alimentare	Manual cu instrucțiuni

2500W ~ 3500W conținut pachet

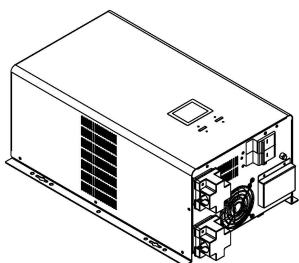

2500W ~ 3500W Invertor

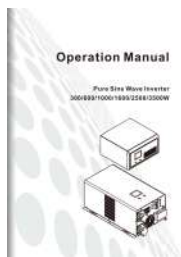

Manual cu instrucțiuni

3.2 Instalarea

AVERTIZARE

Invertorul este conceput pentru utilizare în interior. Nu operați acest UPS în lumina directă a soarelui, în contact cu fluide, sau în locuri unde este prezent praful sau umiditatea în exces.

Plasați bateriile în mediu bine ventilat

Utilizați instrumente izolate pentru a reduce riscul de scurtcircuitare atunci când instalați sau atunci când lucrați cu invertorul, bateriile, sau cu alte echipamente atașate acestor unități.

Asigurați-vă de faptul că terminalul de împământare a fost conectat la împământare.

3.2.1 Informații în privința instalării

- Inspectați dacă tensiunea bateriei și Tensiunea din rețea sunt corecte.
- Conectați invertorul la baterii, la rețeaua electrică și conectați sarcinile/aparatele una câte una la UPS. Asigurați-vă că întregul cablaj este corect, terminalele sunt înșurubate strâns și capacul terminalului este blocat
- Porniți întrerupătorul bateriei, apăsați butonul PORNIT (ON), apoi invertorul intră în funcțiune în 3 secunde, după care verificați dacă încărcarea prezintă probleme (supraîncărcare, scurtcircuit, etc.). În cazul în care constatați probleme, verificați și remediați până când se confirmă că este normal, și apoi conectați la rețeaua de alimentare.

3.2.2 Conectarea bateriei externe

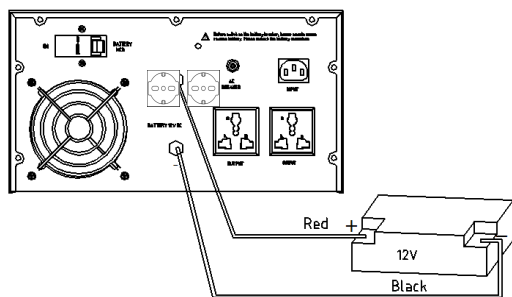

300W / 600W / 1000W DC12V diagramă conexiune baterie inverter

(Acordați atenție faptului că cablul roșu trebuie conectat la terminalul pozitiv, cablul negru la terminalul negativ).

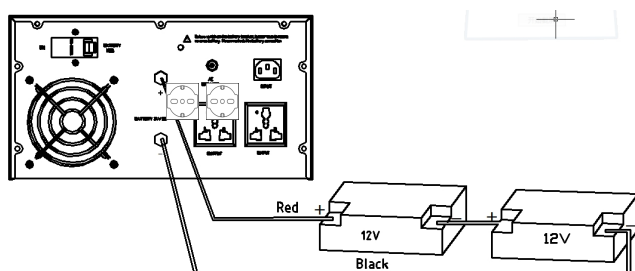

1600W DC24V diagramă conexiune baterie inverter

(Acordați atenție faptului că cablul roșu trebuie conectat la terminalul pozitiv, cablul negru la terminalul negativ).

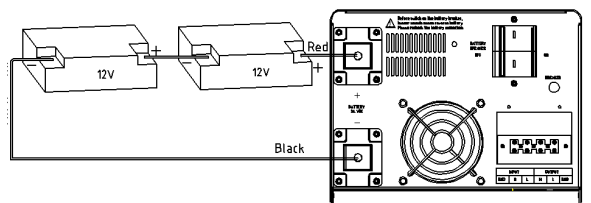

2500W / 3500W DC24V diagramă conexiune baterie inverter

(Acordați atenție faptului că cablul roșu trebuie conectat la terminalul pozitiv, cablul negru la terminalul negativ, și cablul bateriei de 2500W este mai mare de 35 mm², cablul bateriei de 3500W este mai mare de 50 mm²).

4 Operațiuni

AVERTIZARE

Porniți inverterul prima dată pe modul baterie. Asigurați-vă de faptul că încărcarea nu are niciun fel de problemă (supraîncărcare, scurtcircuit, etc.) înainte de a-l conecta la electricitate.

4.1 Porniți/Opriți Inverterul

- Fără a-l conecta la electricitate, apăsați și țineți apăsat butonul "PORNIT" (ON) timp de 3 secunde, eliberați-l până când buzzer-ul sună, inverterul se pornește. În procesul de funcționare al inverterului, apăsați și țineți apăsat butonul "OPRIT" (OFF) timp de 3 secunde, eliberați-l atunci când buzzer-ul sună, inverterul este oprit.
- Atunci când inverterul funcționează în rețeaua principală / modul AC, apăsați și țineți apăsat butonul "OPRIT" (OFF) timp de 3 secunde, eliberați-l atunci când buzzer-ul sună, inverterul trece pe modul bypass.
- Atunci când inverterul funcționează în modul bypass, apăsați și țineți apăsat butonul "PORNIT" (ON) timp de 3 secunde, eliberați-l atunci când buzzer-ul sună, inverterul trece pe modul AC.

4.2 Afișaj interfață

Modul inverter

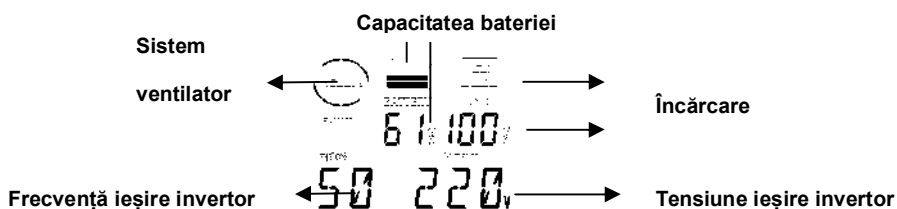

Modul rețea alimentare



4.3 Setările



4.3.1 Setare funcționare

- În modul normal, apăsați și țineți apăsat butonul "PORNIT" (ON) + "OPRIT"(OFF) în același timp pentru 3 secunde pentru a merge la modul Setare.
- În modul Setare, apăsați și țineți apăsat butonul "PORNIT" (ON) + "OPRIT" (OFF) în același timp pentru 3 secunde pentru a ieși din modul setare, și setarea nu este salvată.
- În modul Setare, apăsați butonul "PORNIT" (ON) pentru a trece pe pagina pentru a alege opțiunile de configurare.
- În modul Setare, apăsați butonul "OPRIT" (OFF) pentru a configura setările curente.
- În modul Setare, apăsați butonul "PORNIT" (ON) pentru a întoarce pagina la interfața "Salvare și ieșire", apăsați butonul "OPRIT" (OFF) și alegeți "Y", apoi apăsați butonul "PORNIT" (ON) pentru a confirma datele salvate și ieșiți din modul Setare.
- După ce setările sunt configurate, opriți și restartați inverterul înainte ca setările să aibă efect.
- În modul normal și în starea de pornire, apăsați butonul "OPRIT" (OFF) pentru a-l pune pe silențios.
- În cazul în care există o eroare și eroarea este rezolvată, apăsați prima dată butonul "OPRIT" (OFF) și eliberați-l pentru a apăsa butonul "PORNIT" (ON), și restartați inverterul pentru utilizare normală.

4.3.2 Setările generale

Configurați aceste setări în orice moment, utilizând interfața afișajului.

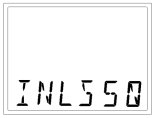





Nr.	Parametrii	Valore Implicită	Opțiuni	Afișaj LCD
1	OUT: Tensiune nominală ieșire a inverterului	220V	220V / 230V / 240V	OUT240
2	HZ: Frecvență nominală ieșire a inverterului	50HZ	50HZ / 60HZ	HZ 60
3	B: Tensiune încărcare egalizare	14.1V	13.6V ~ 15.0V	B 15.0
4	F: Tensiune încărcare plutire	13.5V	13.2V~14.6V	F 14.6
5	E: Finalul tensiunii descărcare	10.2V	9.6V ~ 11.5V	E 11.5
6	CUR: Curent de încărcare	10A (300W) 20A (600W ~ 3500W)	0 ~ 60A	CUR 60
7	IECO: Modul ECO inverter fără încărcare Observație: În cazul în care alegeți "Y", verificați dacă rata de încărcare configurată în "Rată încărcare oprire inverter" este corectă sau nu, dacă nu, schimbați-o.	N	Y / N	IECO N
8	INLS: Funcție de oprire inverter fără încărcare Observație: În cazul în care alegeți "Y", verificați dacă rata de încărcare configurată în "Rată încărcare oprire inverter" este	N	Y / N	INLS N



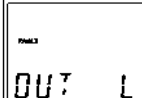
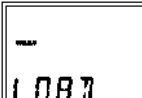
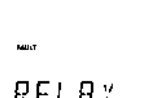
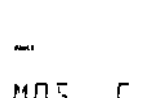

	corectă sau nu, dacă nu, schimbați-o.			
9	DCAU: Funcție de restart automată DC Observație: În cazul în care alegeți "Y", verificați dacă timpul configurat în "Timpul de repornire automată DC" este corect sau nu, dacă nu, schimbați-l.	N	Y / N	DCAU N
10	ACAU: Funcția de pornire automată AC	Y	Y / N	ACAU N
11	INP: Congruență energie intrare a generatorului	120%	10% ~ 120% (pe baza energiei nominale)	INP 120
12	INLS: Rată încărcare oprire inverter	3%	3% ~ 50% (pe baza energiei nominale)	
13	T: Timp repornire automată DC	1 oră	0.5H ~ 8.0H	T 0.0H
14	SAVE: Salvați și ieșiți		Y / N	

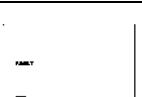
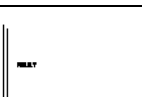
4.4 Remedierea Defecțiunilor

Această secțiune enumeră starea și mesajele de alertă pe care UPS le-ar putea afișa. O acțiune sugerată de corecție este enunțată cu fiecare mesaj de afișare pentru a vă ajuta la remedierea problemelor cu defecțiunile.

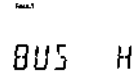
Nr.	Descrierea Problemei	Mesaj Afișat	Acțiune Corecție
1	Scurtcircuit ieșire AC		Verificați dacă sarcina este scurtcircuitată.

2	Tensiunea de ieșire AC este prea ridicată		Contactați furnizorul sau comerciantul de la care a fost achiziționat.
3	Tensiunea de ieșire AC este prea scăzută.		Contactați furnizorul sau comerciantul de la care a fost achiziționat.
4	Supraîncărcare ieșire.		Verificați încărcarea.
5	Eroare releu		Contactați furnizorul sau comerciantul de la care a fost achiziționat.
6	Supra-curent MOSFET		Contactați furnizorul sau comerciantul de la care a fost achiziționat.
7	Temperatură depășită MOS		Îndepărtați din sarcinile conectate. Contactați comerciantul sau furnizorul dacă problema persistă.
8	Conexiunea dintre disipatorul termic și senzorul temperaturii este anormală.		Contactați furnizorul sau comerciantul de la care a fost achiziționat.
9	Supra-temperatură transformator		Îndepărtați din sarcinile conectate. Contactați comerciantul sau furnizorul dacă problema persistă.
10	Tensiunea de ieșire AC a invertorului este prea ridicată		Contactați furnizorul sau comerciantul de la care a fost achiziționat.
11	Tensiunea de ieșire AC a invertorului este prea scăzută		Contactați furnizorul sau comerciantul de la care a fost achiziționat.
12	Eroare pornire SOFT		Contactați furnizorul sau comerciantul de la care a fost achiziționat.

13	Tensiunea BUS este prea ridicată (Bateria este supraîncărcată)		Verificați tensiunea bateriei. Contactați comerciantul sau furnizorul dacă problema persistă.
14	Supra-curent încărcare		Contactați furnizorul sau comerciantul de la care a fost achiziționat.
15	Tensiunea bateriei este prea ridicată		Verificați tensiunea bateriei.
16	Protecție împotriva supra-descărcării bateriei		Verificați tensiunea bateriei.
17	Eroare blocare automată		Așteptați pentru revenire automată sau pentru oprirea manuală și reporniți inverterul.

Informatii ecologice:

Deseurile de echipamente electrice si electronice sunt o categorie speciala de deseuri , colectarea , depozitarea , tratata si reciclata sunt importante deoarece se pot evita poluari ale mediului cu gaze de efect de sera sau metale grele,si care pot fi daunatoare sanatatii.Depunand la centrele speciale de colectare a DEEE, va debarasati responsabil de aceste deseuri, va asigurati ca acestea ajung sa fie reciclate corect si totodata protejati natura.Nu uitati! Fiecare aparat electric ajuns la groapa de gunoi , pe camp sau pe malul apei polueaza! Simbolul (pubela taiata cu un x) reprezinta obiectul unei colectari separate a EEE:



Importator si distribuitor:

SC VITACOM ELECTRONICS SRL

CIF: RO 214527

Tel. 0264-438401*

suport@vitacom.ro

www.vitacom.ro



well[®]

Felhasználói kézikönyv

Valós szinuszos inverter

Model

UPS-HEATST-COMMANDER300W-WL

UPS-HEATST-COMMANDER600W-WL

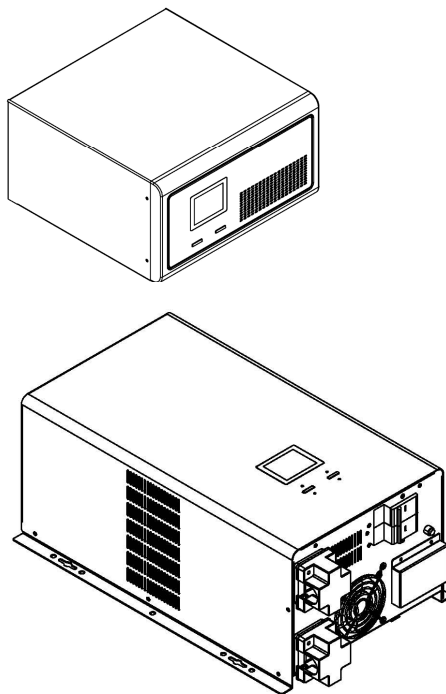

Ez a termék 2 +1 éves garanciával rendelkezik.
Részletes információk megtalálhatók a www.well.ro web oldalon.

Köszönjük hogy WELL terméket választott. Használat előtt kérjük olvassa el figyelmesen az alábbi utasításokat és tartsa kézügyben őket.

1 Biztonsági előírások

FIGYELMEZTETÉS
Nem szakavatott villanyszerelőnek tilos kinyitni a dobozt, mert áramütés veszélye áll fent.
Ez a berendezés nem alkalmazható az alábbi, vagy hasonló alkalmazásokhoz: Orvosi célú alkalmazás, amely közvetlenül kapcsolódik a betegek életéhez. <ul style="list-style-type: none">• Emelő szerkezet, és egyéb berendezés, amely veszélyeztetheti a személyes biztonságot.• Forgalom irányító rendszerek, repülési, aerospace alkalmazások• Biztonsági berendezések, egyéb különleges alkalmazások

Általános óvintézkedések és figyelmeztetések

- Az inverter használata előtt figyelmesen olvassa el a biztonsági információkat és használati utasítást.
- Ne szerelje szét a invertert. Ha karbantartás vagy javítás szükséges, forduljon a helyi szervizközponthoz.
- Karbantartás vagy tisztítás előtt húzza ki az összes vezetékét, hogy elkerülje az áramütés veszélyét.
- Ha tűz ütött ki, ne használjon folyékony tűzoltó készüléket, száraz poroltót ajánlott használni.
- Ne dobja az elemeket tűzbe. Az elemek felrobbanhatnak.
- Ne nyissa fel, ne rongálja az elemeket. A belülről kifolyó elektrolit káros a bőrre és a szemre, és talán mérgező.
- Ne csatlakoztassa közvetlenül a pozitív pólust és a negatív pólust, különben áramütés keletkezhet, vagy tüzet okozhat.

2 A termék áttekintése

2.1 Tulajdonságok

MODEL	300W	600W	1000W	1600W	2500W	3500W
DC Bemenet (a megfelelő működéshez az invertert akumulátorhoz kell csatlakoztatni.)						
Névleges bemeneti feszültség	12V			24V		
DC bemeneti tartomány	10 ~ 15V			20 ~ 30V		
AC Bemenet						
Bypass bemeneti tartomány	220Vac/230Vac/240Vac részére 0 ~ 264Vac					
Hálózati bemeneti tartomány	220Vac részére 150 ~ 282Vac, 230Vac részére 156 ~ 294Vac, 240Vac részére 163 ~ 307Vac					
Bemeneti frekvencia tartomány	50Hz / 60Hz (Auto-sense), 50Hz részére 45 ~ 55Hz, 60Hz részére 55 ~ 65Hz					
A generátor bemeneti tartományban	220Vac részére 99 ~ 282Vac, 230Vac részére 104 ~ 294Vac, 240Vac részére 108 ~ 307Vac		Generátor módban nincs áramszabályzás			
A generátor bemeneti frekvenciatartománya	40 ~ 70Hz					
A generátornak megfelelő bemeneti teljesítmény	Névleges teljesítmény 10% ~ 120%, szabályozó lépés 10%, alapértelmezett 120%					
Kimenet						
Inverter kimeneti tartomány	220V / 230V / 240Vac ± 5%					
Bypass kimeneti tartomány	220V/230V/240V, részére 0 ~ 264Vac					
Hálózati kimeneti tartomány	220Vac részére 174 ~ 242Vac, 230Vac részére 182 ~ 253Vac, 240Vac részére 190 ~ 264Vac					
Kimeneti frekvencia	50Hz / 60Hz ± 0.3 (Auto-érzékeny & beállítható)					
Kimeneti hullám forma	Valós szinuszos hullám					
Kimeneti teljesítmény	300W	600W	1000W	1600W	2500W	3500W
Hatékonyosság	Max. 95% (Hálózati üzemmód); Max. 80% (Inverter mód)					
ECO mód	Ha a terhelés kisebb mint 3%, 80 mp után belép					
Üresjárat leállítás	Állítható, leállítás 80 mp alatt. Állítható, 80 mp alatt kilép					
Terhelés az üresjárat leállításban	Állítható, 3% ~ 50% opcionálisan, alapértelmezett 3%					
Átadási idő	≤10 mmp				≤ 15 mmp	
Teljesítmény faktor	1.0					
THDV	< 5% (lineáris terhelés)					

Induktív terhelés	Igen					
Motor terhelés	Igen					
Egyenirányító terhelés	Igen					
Túlterhelhetőség	Hálózati üzemmód: 110% 120 mp, 125% 60 mp, 150% 10 mp (bypass-ra vált) Inverter mód: 110% 60mp; 125% 10 mp; 150% 0.7 mp (lezár)					
Akkumulátor						
Töltőáram (választható)	Alapértelmezett 10A	Alapértelmezett 20A, szabályozó lépés 1A (< 10A) / 5A (> 10A)				
	Max. 15A	Max. 30A	Max. 40A	Max. 40A	Max. 50A	Max. 60A
Kiegyenlítő töltőfeszültség	Egy akkumulátor 14.1Vdc (alapértelmezett), 13.6 ~ 15Vdc állítható					
Átmeneti töltőfeszültség	Egy akkumulátor 13.5Vdc (alapértelmezett), 13.2 ~ 14.6Vdc állítható					
EOD	Egy akkumulátor 10.2Vdc (alapértelmezett), 9.6 ~ 11.5Vdc állítható					
Fordított polaritás jelző	Berregő					
Riasztás						
Vált be/ki, on / off	Folyamatos sípolás 2 mp					
Alacsony töltöttség	Sípol 0.2 mp-től 0.4 mp-es időintervallumon át					
Túltöltés	Sípol 2 mp-től 2.5 mp-es időintervallumon át					
Rendellenes tápellátás	Sípol 0.3 mp-től 5 mp-es időintervallumon át					
Egyebek						
Védekezés	Túlterhelés -rövid-zárlat - túlfeszültség - feszültségcsökkenés - túltöltés - túlmelegedés - túlzottan alacsony akkumulátorszint					
Interfész	LCD & RIASZTÁS					
Zajszint	≤50dB					
IP védettség	IP20					
Működési hőmérséklet	0°C ~ 40°C					
Működési páratartalom	Relatív páratartalom ≤ 93%					
Magasság	< 1000m, (1000m fölött, minden egyes 100 m után 1%-os), 4000 m max.					
Nettó súly (kg)	8.3	11.3	14.0	20.2	32.0	36.0
Bruttó súly (kg)	9.3	12.3	15.0	21.2	34.0	38.0
Méretetek (W×D×H) mm	293×280×160				302×479×209	
A csomagolás méretei (W×D×H) mm	370×355×235				353×582×287	

Megjegyzés: A műszaki adatok előzetes értesítés nélkül megváltoztathatóak.

A töltés jellemzői

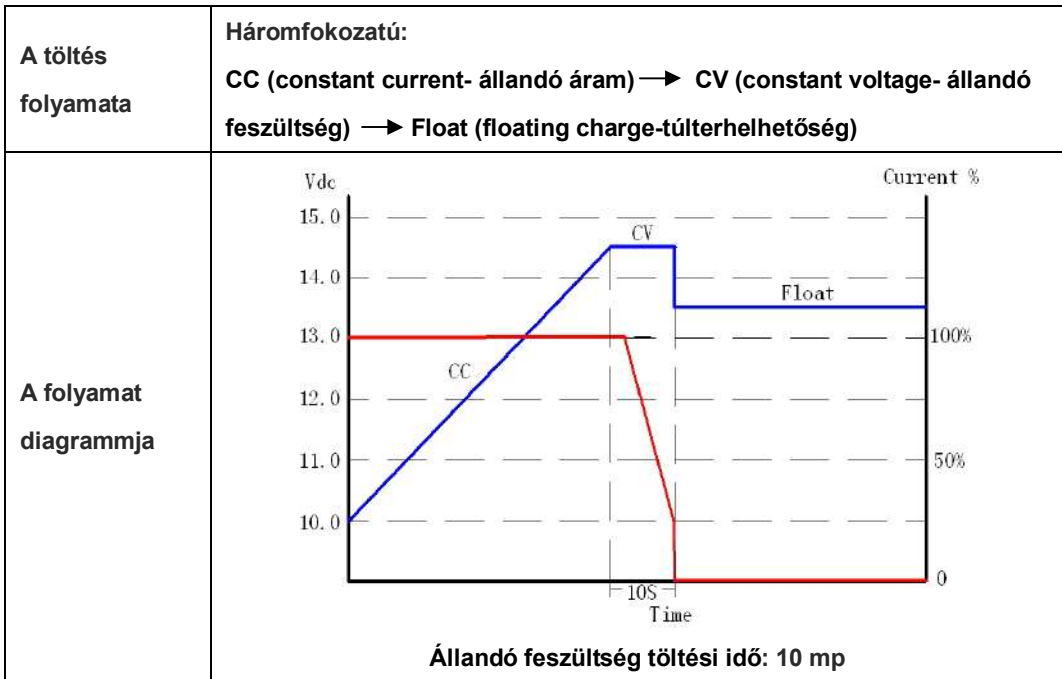

2.2 Az előlap funkciói

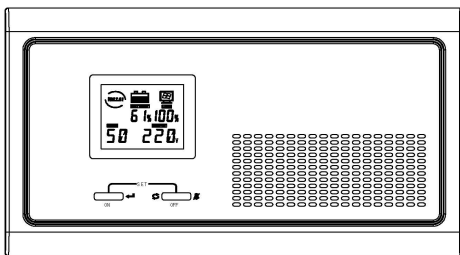

300W ~ 1600W előlap

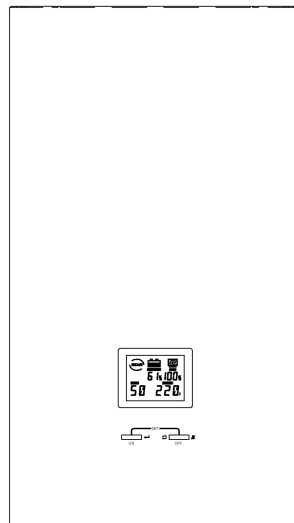

2500W ~ 3500W előlap

2.3 Hátsó panel jellemzői

300W ~ 1600W hátsó panel

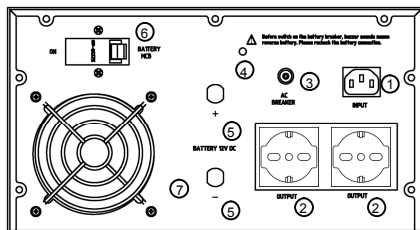

- ① AC bemeneti foglalat
- ② Kimeneti foglalatok
- ③ Túláram elleni védelem
- ④ Riasztó fordított elem polaritás
- ⑤ Akkumulátor bekötése
- ⑥ Akkumulátor megszakító
- ⑦ Ventilátor

2500W ~ 3500W hátsó panel

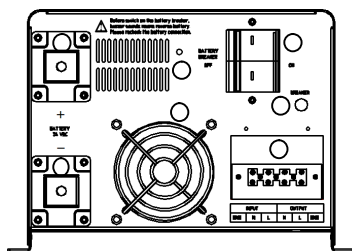



- ① Bemenet / kimenet terminál blokk
- ② Túláram elleni védelem
- ③ Akkumulátor megszakító
- ④ Riasztó a fordított elem polaritás
- ⑤ Akkumulátor bekötési terminálja
- ⑥ Ventilátor

3 Beszerelési útmutató

3.1 Ellenőrizze a csomagolást

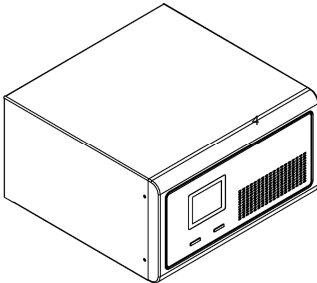
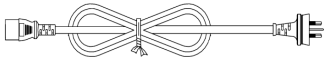
Kézhezvétel után vizsgálja meg a csomag tartalmát. Ha a készülék sérült, haladéktalanul értesítse a szállítót és a forgalmazót.

300W ~ 1600W csomag tartalma		
		
300W ~ 1600W Inverter	AC bemeneti tápkábel	Használati kézikönyv

2500W ~ 3500W csomag tartalma

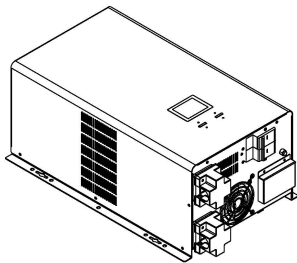

2500W ~ 3500W Inverter

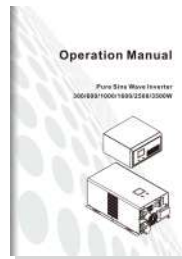

Használati kézikönyv

3.2 Beszerelés

VIGYÁZAT

Az invertert beltéri használatra tervezték. Ne használja jelen UPS-t közvetlen napfény közelében, vagy ahol sok a por vagy a nedvesség, ne érintkezzen folyadékokkal.

Tárolja az elemeket jól szellőző környezetben.

Ha beszereli vagy dolgozik az inverteren, az akkumulátorral vagy egyéb, az egységhez mellékelt berendezéseken, a rövidzárlat veszélyének csökkentése érdekében használjon szigetelt eszközöket.

Bizonyosodjon meg róla, hogy a földelő kapcsot csatlakoztatta a talajhoz.

3.2.1 Beszerelési adatok

- Ellenőrizze, hogy az akkumulátor feszültsége és a hálózati feszültség helyes vagy sem.
- Csatlakoztassa az invertert akkumulátorokhoz, a hálózati feszültséghez és a terheléshez. Bizonyosodjon meg, hogy az összes kábelt helyesen csatlakoztatta, a terminálokat szorosán becsavarozta, és hogy a csatlakozó fedele le van zárva.
- Kapcsolja be az akkumulátor megszakítót, nyomja meg az ON/BE gombot, majd 3 másodpercen belül az inverter beindul, és azután ellenőrizze, hogy a terhelésben van-e gond (túlterhelés, rövidzárlat, stb.). Ha igen, akkor ellenőrizze, és helyesbítse, amíg normál lesz a megerősítés, majd csatlakoztassa a hálózati feszültségre.

3.2.2 Csatlakozás külső akkumulátorhoz

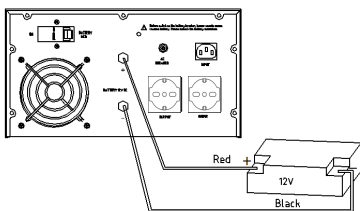

300W / 600W / 1000W DC12V inverter akkumulátor bekötési rajza

(Vegye figyelembe, hogy a piros kábel a pozitív terminálhoz van csatlakoztatva, a fekete kábel a negatív terminálhoz van csatlakoztatva)

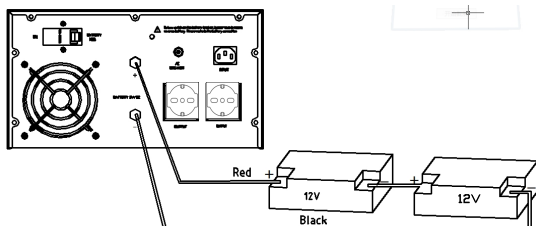

1600W DC24V inverter akkumulátor bekötési rajza

(Vegye figyelembe, hogy a piros kábel a pozitív terminálhoz van csatlakoztatva, a fekete kábel a negatív terminálhoz van csatlakoztatva.)

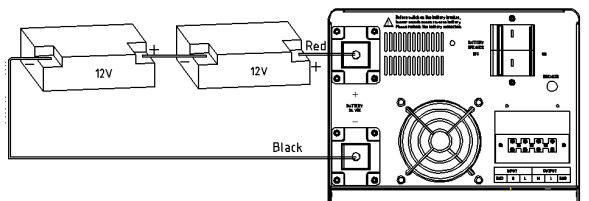

2500W / 3500W DC24V akkumulátor bekötési rajza

(Vegye figyelembe, hogy a piros kábel a pozitív terminálhoz van csatlakoztatva, a fekete kábel a negatív terminálhoz van csatlakoztatva, és hogy a 2500W akkumulátor kábel több mint 35mm², a 3500W akkumulátor kábel pedig több mint 50mm²)

4 Műveletek

VIGYÁZAT

Először kapcsolja be az invertert akkumulátor üzemmódba. Mielőtt csatlakoztatja a hálózathoz ellenőrizze, hogy a terhelésben ne legyen gond (túlterhelés, rövidzárlat, stb.).

4.1 Állítsa az invertert ON/ OFF, BE/KI pozícióba

- A hálózathoz való csatlakozás nélkül, nyomja meg a "ON/BE" gombot 3 másodpercig, engedje el, amíg a riasztó hangjelzést ad, az inverter elindul. Az inverter működési folyamata során nyomja meg az "OFF/KI" gombot 3 másodpercig, engedje el, amíg az a hangjelzést ad, az inverter kikapcsol.
- Amikor az inverter hálózati / AC módban működik, nyomja meg és tartsa az "OFF/KI" gombot 3 másodpercig, engedje el, amíg a riasztó hangjelzést ad, az inverter bypass módba áll.
- Amikor az inverter bypass módban működik, nyomja meg és tartsa az "ON/BE" gombot 3 másodpercig, engedje el, amíg a riasztó hangjelzést ad, az inverter AC üzemmódba áll.

4.2 A kijelző interfésze

Inverter mód

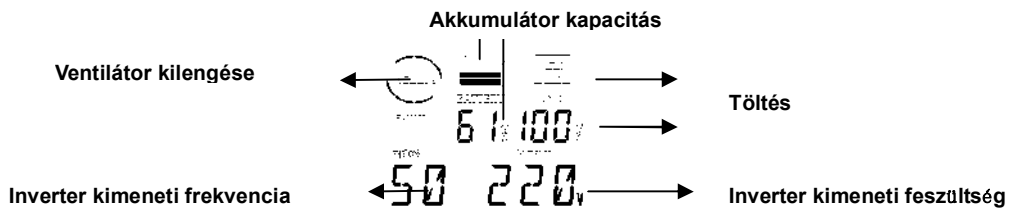

Hálózati teljesítmény üzemmód



4.3 Beállítások

4.3.1 Beállítási műveletek

- Normál üzemmódban nyomja meg egyszerre a "BE/ON" + "KI/OFF" gombot és tartsa 3 másodpercig, hogy a Beállítás módba lépjen.
- A Beállítás módban nyomja meg egyszerre a "BE/ON" + "KI/OFF" gombot és tartsa 3 másodpercig, hogy a Beállítás módból kilépjen, a beállításokat nem fogja menteni.
- A Beállítás módban a lapozáshoz nyomja meg az "ON/BE" gombot, hogy kiválassza a beállítási lehetőségeket.

- A Beállítás módban az "OFF/KI" gombra kattintva lehet beállítani az aktuális beállításokat.
- A Beállítás módban nyomja meg az "ON/BE" gombot, hogy lapozzon a "Save & Exit/Ment & Kilép" felület oldalára, nyomja meg az "OFF/KI" gombot, és válassza ki a "Y", majd nyomja meg az "ON/BE" gombot, hogy mentse az adatokat és lépjen ki a Beállítás módból.
- A beállítások elvégzése után zárja le és indítsa újra az invertert, mielőtt a beállítások érvénybe lépnek.
- Normál módban és a kiindulási állapotban, a némításhoz nyomja meg az "OFF/KI" gombot.
- Ha van hiba és hiba megoldódott, nyomja meg az "OFF/KI" gombot először, majd nyomja meg az "ON/BE" gombot, és indítsa újra az invertert normál használatban.

4.3.2 Általános beállítások

A kijelző interfészét használva, bármikor használhatja ezeket a beállításokat.

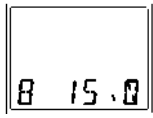
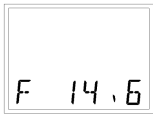
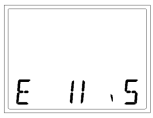



Szám	Paraméterek	Alapértelmezett érték	Opciók	LCD kijelző
1	OUT: Az inverter névleges kimeneti feszültsége	220V	220V / 230V / 240V	OUT240
2	HZ: Az inverter névleges kimeneti frekvenciája	50HZ	50HZ / 60HZ	HZ 60
3	B: Töltőfeszültség kiegyenlítés	14.1V	13.6V ~ 15.0V	
4	F: Átmeneti töltőfeszültség	13.5V	13.2V~14.6V	
5	E: Kisülési feszültség vége	10.2V	9.6V ~ 11.5V	





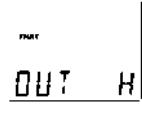
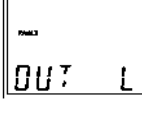

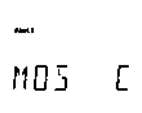
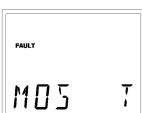
6	CUR: Töltőáram	10A (300W) 20A (600W ~ 3500W)	0 ~ 60A	CUR 60
7	IECO: Az inverter üresjáratú ECO módja. Megjegyzés: Ha az "Y"-t választja, ellenőrizze, hogy a beállított terhelési ráta "Inverter-leállító terhelése" helyes-e vagy nem, ha nem, akkor változtassa meg.	N	Y / N	IECO N
8	INLS: Az inverter üresjáratú leállító funkció. Megjegyzés: Ha az "Y"-t választja, ellenőrizze, hogy a beállított terhelési ráta "Inverter-leállító terhelése" helyes-e vagy nem, ha nem, akkor változtassa meg.	N	Y / N	INLS N
9	DCAU: DC automatikus újraindítás funkció Megjegyzés: Ha az "Y"-t választja, ellenőrizze, hogy a beállított idő "DC auto restart time" helyes-e vagy nem, ha nem, akkor változtassa meg.	N	Y / N	DCAU N
10	ACAU: AC önindító funkció	Y	Y / N	ACAU N
11	INP: A generátornak megfelelő bemeneti teljesítmény	120%	10% ~ 120% (a névleges teljesítmény alapján)	INP 120
12	INLS: Inverter-leállító terhelés mértéke	3%	3% ~ 50% (a névleges teljesítmény alapján)	INLS 50
13	T: DC automatikus újraindítás ideje	1H	0.5H ~ 8.0H	T 8.0H

14	SAVE: Ment és kilép		Y/N	
----	---------------------	--	-----	--

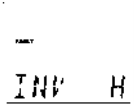
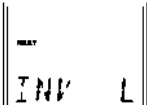
4.4 Hibaelhárítás

Ez a rész azokat az állapotokat és riasztási üzeneteket listázza, amelyek az UPS-en jelenhetnek meg. A javasolt korrekciós intézkedés szerepel minden üzenetben a kijelzőn, hogy segítsen megoldani a problémákat.

Sz.	A probléma leírása	Üzenet megjelenítése	Korrekciós intézkedések
1	AC kimeneti rövidzár		Ellenőrizze hogy a terhelés rövidzárlatos-e.
2	AC kimeneti feszültség túl magas		Lépjen kapcsolatba a kereskedővel vagy a forgalmazóval, akitől vásárolta.
3	AC kimeneti feszültség túl alacsony		Lépjen kapcsolatba a kereskedővel vagy a forgalmazóval, akitől vásárolta.
4	Kimeneti túlterhelés		Ellenőrizze a terhelést.
5	Reléhiba		Lépjen kapcsolatba a kereskedővel vagy a forgalmazóval, akitől vásárolta.
6	MOSFET túláram		Lépjen kapcsolatba a kereskedővel vagy a forgalmazóval, akitől vásárolta.
7	MOS túlmelegedés		Csökkentse az üzemi terhelést. Lépjen kapcsolatba a kereskedővel vagy a forgalmazóval, ha a probléma továbbra is fennáll.
8	A bordás fűtőtest és a hőmérsékleti szenzor csatlakozása nem normal.		Lépjen kapcsolatba a kereskedővel vagy a forgalmazóval, akitől vásárolta.

9	Transzformátor túlmelegedés		Csökkentse az üzemi terhelést. Lépjen kapcsolatba a kereskedővel vagy a forgalmazóval, ha a probléma továbbra is fennáll.
10	Az inverter AC kimeneti feszültsége túl magas		Lépjen kapcsolatba a kereskedővel vagy a forgalmazóval, akitől vásárolta.
11	Az inverter AC kimeneti feszültsége túl alacsony		Lépjen kapcsolatba a kereskedővel vagy a forgalmazóval, akitől vásárolta.
12	Szoft-start hiba		Lépjen kapcsolatba a kereskedővel vagy a forgalmazóval, akitől vásárolta.
13	BUS feszültség túl magas (Az akkumulátor túlterhelt)		Ellenőrizze az akkumulátor feszültségét. Lépjen kapcsolatba a kereskedővel vagy a forgalmazóval, ha a probléma továbbra is fennáll.
14	Túláram töltés		Lépjen kapcsolatba a kereskedővel vagy a forgalmazóval, akitől vásárolta.
15	Az akkumulátor feszültsége túl magas		Ellenőrizze az akkumulátor feszültségét.
16	Az akkumulátor túlterhelése elleni védelem		Ellenőrizze az akkumulátor feszültségét.
17	Önzáró-hiba		Várjon az autamikus klíringre vagy manuálisan állítsa le, és indítsa újra az invertert.

A használt elektromos es elektronikus keszulekek specialis hulladek kategoriaba tartoznak, begyujtesuk, tarolasuk es ujrafeldolgozasuk fontos, ezalltal elkerulhetjuk az uveghaz hatast okozo gazok vagy nehezfemek alltal okozott kornyezeti szennyezodest,

melyek tartalmaznak az emberi egészségre és testi épségére.

Ez okból kifolyólag kérjük a használt elektromos és elektronikus készülékeket, berendezéseket, leadni az erre a célra létrehozott speciális hulladék gyűjtő központokba, ezáltal hozzájárulva a helyes újrahasznosítási folyamathoz, oltalmazva környezetünket és erőforrásainkat.

Ne feledje! Minden egyes elektromos és elektronikus készülék amely a hulladék lerakóhoz, a földre , vagy a víz partjára kerül szennyezi a környezetet!

Az elkülönített gyűjtést igénylő , hulladékká vált elektromos , elektronikus berendezés jelölése:

Beszállító és forgalmazó:

VITACOM ELECTRONICS Kft.

Egyéni nyilvántartási kód: RO 214527

400495 Kolozsvár (Cluj-Napoca), Bună Ziua u. SZ.N.

Tel: +40-264-438401*

export@vitacom.ro

www.vitacom.ro



DECLARATIE DE CONFORMITATE EC

Noi, SC VITACOM ELECTRONICS SRL, cu sediul in Cluj-Napoca, str. Buna Ziua FN, CIF RO 214527, înregistrată la Oficiul Registrului Comerțului cu nr. J12/1992/1991, asiguram, garantam si declaram pe propria raspundere, conform prevederilor Art. 5 din Hotararea Guvernului nr. 1.022/2002 privind regimul produselor si serviciilor care pot pune in pericol viata, sanatatea , securitatea muncii si protectia mediului, ca produsul :

SURSA NEINTRERUPTIBILA PENTRU CENTRALE TERMICE

Model: UPS-HEATST-COMMANDER300W-WL
UPS-HEATST-COMMANDER600W-WL

la care se refera aceasta declaratie nu pune in pericol viata, sanatatea, securitatea muncii, nu produce un impact negativ asupra mediului si este in conformitate cu urmatorul/urmatoarele standard/standarde sau cu alti/alte document/documente normative :

- EN 60950-1:2006+A11:2009+A1:2010+A12:2011+A2:2013
- EN 61000-6-4:2007 +A1:2011
- EN 61000-6-2:2005;

Declaratia de conformitate respecta cerintele:

- HG 457/08.05.2003 republicata, Directiva LVD 2014/35/EU, J. Of. Seria L, nr. 374/27.12.2006, Seria L, nr. 96/29.03.2014
- HG 57/28.01.2015, Directiva EMC 2014/30/EU, J. Of. Seria L, nr. 390/31.12.2004, Seria L, nr. 96/29.03.2014

Prezenta declaratie a fost intocmita pe baza documentatiei obtinuta de la producator.

An de aplicare a marcajului CE: 2016.

Kun-Jager Francisc
Manager aprovizionare

Locul si data emiterii declaratiei:
Cluj-Napoca, 22.08.2016



